



[www.cometsystem.com](http://www.cometsystem.com)

Instruction manual

# Commeter D3121P

Digital thermometer-hygrometer and datalogger  
for compressed air measurement

---

# Table of contents

GENERAL DESCRIPTION .....	3
TECHNICAL PARAMETERS .....	4
Measured and calculated values .....	4
General .....	5
Operation conditions .....	6
Dimensions .....	8
OPERATION OF THE DEVICE .....	9
Switching ON and OFF the device .....	9
Displaying of actual measured values .....	9
Function HOLD (storing of actual measured values) and minimum a maximum memory .....	10
Functions and settings available from menu .....	10
Alarm indication and setting .....	12
LOGGING MODE .....	13
Logging start from device keyboard .....	13
Logging start with clearing memory and logging mode selection .....	14
Logging stop from keyboard .....	15
CONNECTION OF THE DEVICE TO A PERSONAL COMPUTER .....	16
THE PC SOFTWARE FOR THE DEVICE .....	17
Installation of program for PC with OS Windows .....	17
Software for Windows – instruction manual .....	17
BATTERY REPLACEMENT .....	19
TECHNICAL SUPPORT AND SERVICE .....	20
APPENDIX A .....	21

---

## General description

Instrument is designed for measurement and logging temperature and relative humidity of the compressed air with the possibility of displaying the dew point temperature. Measured values are displayed on a dual line LCD display and it is possible to store values into the non volatile memory. Then it is possible to transfer data to a personal computer. Temperature is measured by RTD sensor Ni1000/6180ppm. Instrument compares measured values of temperature, humidity and dew point with two adjustable levels for each measured quantity. Breaking the level is indicated by blinking the proper value on display and by audio indication (switchable). Instrument is equipped with minimum and maximum memory and Hold function. Minimum and maximum values and Hold value are possible to display on the LCD anytime.

The sensing element of the device is the external probe designed for compressed air measurement up to 25 bars. It is good to mount probe directly into high pressure area (i.e. air pressured pipe) if it is possible. There is other possibility to use flow chamber SH-PP, see Appendix A.

---

# Technical parameters

---

## Measured and calculated values

### Temperature:

Measuring range: -30 to +105 °C  
Resolution: 0.1 °C  
Accuracy:  $\pm 0.4$  °C  
Response time:  $t_{90} < 9$  min with sensor cover with filter from stainless steel mesh

---

Air flow approximately 1m/s, temperature step 20 °C

### Relative humidity:

Measuring range: 0 to 100 %RH  
Resolution: 0.1 %RH  
Accuracy:  $\pm 2.5$  %RH from 5 to 95 %RH at 23 °C  
Response time:  $t_{90} < 30$  s with sensor cover with filter from stainless steel mesh

---

Air flow approximately 1m/s, humidity step 65 %RH, constant temperature

### Dew point temperature:

Measuring range: -50 to +80 °C  
Resolution: 0.1 °C  
Accuracy:  $\pm 1.5$  °C at temperature  $T < 25$  °C and  $RH > 30\%$   
(for more details see graphs)

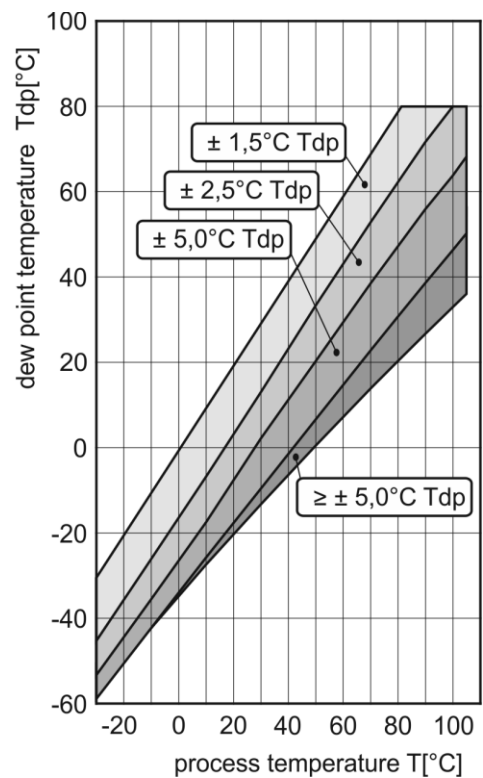
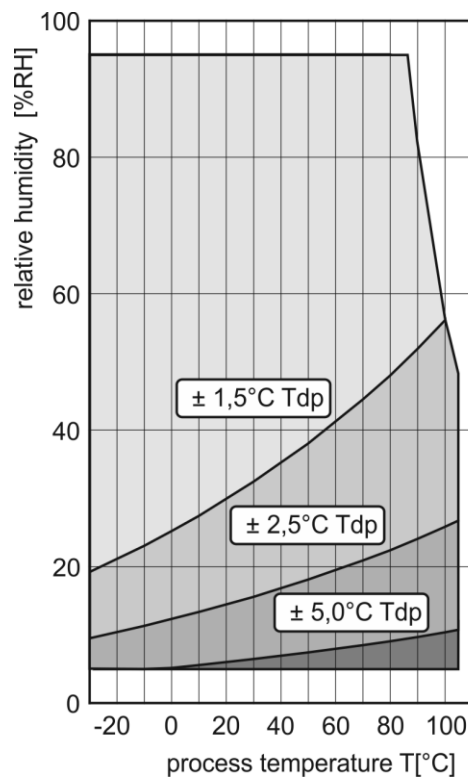

---

## General

### Measuring interval and display reading refresh approximately:

0.7 s	in FAST mode
0.7 to 5 s	in dynamic mode

### Logging interval:

10 s to 24 h (in automatic logging mode)

### Total memory capacity:

1000 sets of all input quantities	manual logging mode
8124 values	automatic noncyclic logging mode
7644 values	automatic cyclic logging mode

---

The above specified numbers are maximum possible. Capacity is slightly lower if logging was interrupted by communication with computer, by stopping logging or switching OFF the instrument.

### Real time clock:

Adjustable from computer, integrated calendar including leap years  
Real time clock accuracy: < 200 ppm (i.e. 0.02 %, 17.28 s in 24 h)

### Power:

Battery 9V or ac/dc adapter 12 V with NiMH accumulator 9V

---

If instrument is supplied from external ac/dc adapter, internal 9V battery should be replaced with rechargeable NiMH accumulator. In usual operation from adapter accumulator is charged only with small current. If accumulator is totally discharged, its full charging in instrument takes approximately 100 hours. Instrument with accumulator is not recommended for permanent operation without ac/dc adapter plugged. Accumulator works only as a standby source in case of power mains failure.

### Average current consumption:

0.15 to 0.7 mA (depending on operation mode)

---

Battery life depends on selected display refresh mode (see below). In FAST mode display is refreshed in shortest possible interval with highest current consumption. In dynamic mode display is refreshed in interval up to 5 s in case measured values remain stable. Refresh interval is shortened to approximately 0.7 s only if measured values change. Current consumption in this mode in usual operation is lower, battery life is up to 4 times longer. The FAST mode is recommend to use only in cases, when slower display response is not acceptable.

Battery voltage drop below 7 V is indicated with blinking of "BAT" in default display mode (displaying of actual values) and FAST mode is automatically cancelled to save the battery. At the same time audio indication of alarms is automatically switched OFF.

---

**Electromagnetic compatibility:**

Device conforms in accordance with EN 61326-1 these norms:

Radiation:	EN 55022	class B
Immunity:	EN 61000-4-2	(levels 4/8 kV, class A)
	EN 61000-4-3	(intensity of electromagnetic field 3 V/m, class B)
	EN 61000-4-4	(levels 1/0.5 kV, class A)
	EN 61000-4-6	(intensity of electromagnetic field 3 V/m, class B)
	EN 61000-4-11	(class A)
	EN 61000-4-5	(class A)

**Communication with computer:**

USB port (USB mini connector)

**Display:**

Backlit two-line LCD

Backlighting turns off automatically 10 seconds after the last keystroke

**Protection:**

IP20 device, sensors are located in cover with IP40 protection

**Dimensions:**

141 x 71 x 27 mm

**Weight:**

Approximately 150 g including battery without probe

**Material of the probe housing:**

Duralumin with the black eloxal surface finish

---

**Operation conditions****Ambient temperature operating range:**

-10 to +60 °C, device  
-30 to +105 °C, probe

**Ambient rel. humidity operating range:**

5 to 95 %RH (no condensation), device  
0 to 100 %RH, probe

**Temperature and rel. humidity restriction:**

The measuring range of the external probe is limited in accordance with the graph and must not be exceeded!

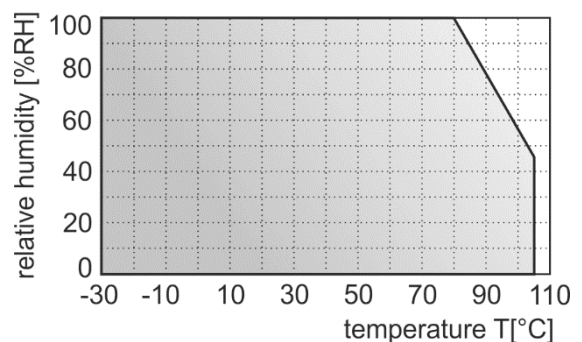

---

**Operating pressure range of the probe:**

Up to 25 bar

**Air flow velocity:**

Up to 25 m/s at a pressure of 1 bar (1 m/s at a pressure of 25 bar)

**Mechanical connection of probe:**

G1/2 with O-ring

**Working position of the probe:**

Vertical with the cover downwards

**Not allowed manipulation:**

- It is not allowed to touch the sensors under the cover to prevent damage the sensors.
- The sensors (under the cover) should not be exposed to direct contact with water or other liquids.
- Dismounting of the probe must not be carried out under the pressure.

---

## Dimensions

---

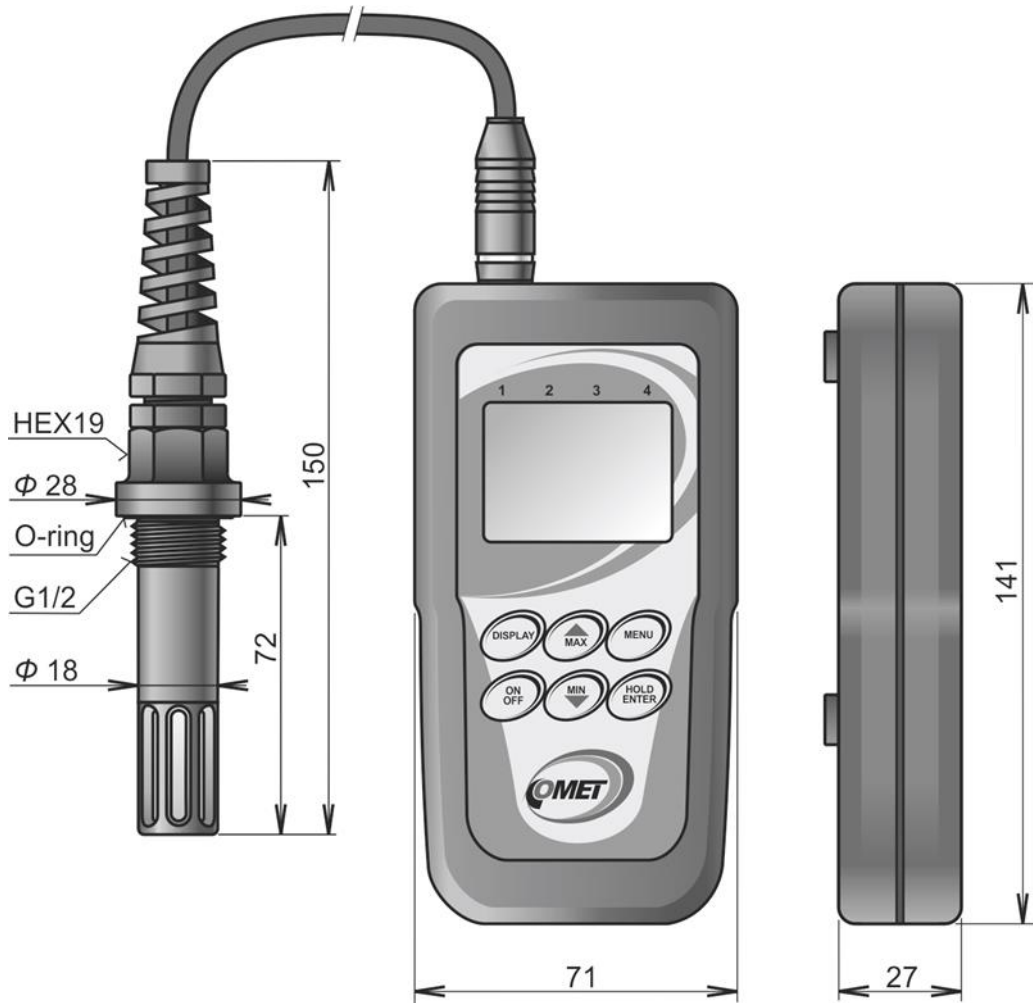



---

# Operation of the device

---

## Switching ON and OFF the device

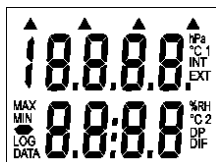

Switch ON the instrument by pressing ON/OFF key. After switching ON the instrument all symbols on the LCD are displayed. If the ON/OFF key is being held pressed, all LCD symbols are displayed till the key is released. In usual operation instrument then starts the measurement mode and actual measured values are displayed.

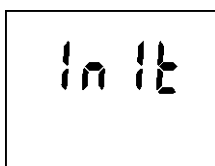

If a voltage drop below critical limit occurred since last adjustment of internal real time clock or battery disconnection longer than approximately 1 min, new instrument initialisation is performed (reading INIT could be displayed up to 12 s !).

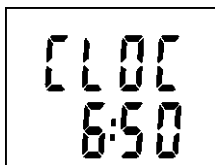

After initialization is finished instrument starts to display internal time to warn to incorrect internal time. New time adjustment is performed by the computer. Press MENU key to switch instrument to actual measurement mode.

It is possible to switch OFF the instrument anytime, all instrument setting is kept saved. If automatic logging was active before instrument is switched OFF, logging will continue with the same parameters after new switching ON.

---

## Displaying of actual measured values

In this mode is instrument anytime after switching ON. It is possible to enter this mode from other modes by pressing or by repeating pressing of MENU key.

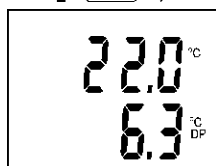
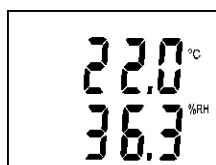

Temperature is displayed on the upper LCD line (°C) and relative humidity in %RH is displayed on the lower LCD line.

Press DISPLAY key to display other readings - temperature in °C on upper line and dew point temperature on lower line (°C DP).

---

## Function HOLD (storing of actual measured values) and minimum a maximum memory

Press HOLD key in the default mode (displaying of actual measured value) to store actual measured values to internal memory (indicated by short beep). Anytime it is possible to display stored values from MENU (see below). Each pressing of the HOLD key in the default mode causes values stored in HOLD memory are replaced with actual ones.

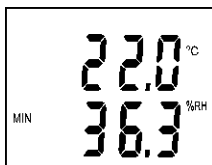

Switched ON instrument permanently updates minimum and maximum memory of each measured values. Press MIN key (resp. MAX key) in the default mode to display minimum (resp. maximum) reading. These minimum and maximum readings are indicated by MIN (MAX) symbols on the LCD. Press DISPLAY key to display minimum (resp. maximum) value of other values. Pressing MIN (MAX) or MENU key again to return to default mode. Minimum and maximum memory is cleared from menu after confirmation selection CLR (see below). Values in HOLD, MIN and MAX memories remain stored even after instrument is switched OFF.

---

## Functions and settings available from menu

Press MENU key to enter mode of viewing menu items one by one. Press arrow keys up and down to list all menu items. Press MENU key again to return to default mode (displaying of actual measured values).

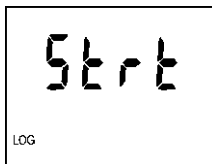

First selection is START/STOP logging. There are two possibilities: if logging is stopped, logging start is offered (symbol Strt = START), if logging is in progress already, logging stop is offered (reading STOP). Press ENTER key to confirm one of two possibilities. Notice: if battery voltage is low it is not possible to start logging.

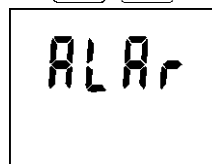

Press ENTER key to enter alarm setting mode (see below).

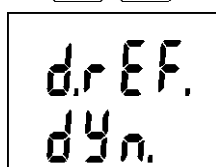
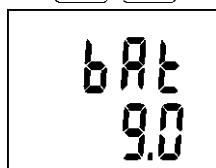
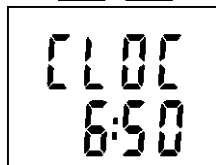
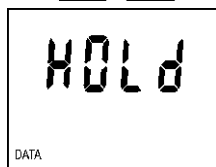
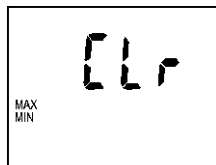
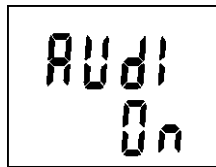

This item indicates if audio signaling of alarm indication is switched on (On) or switched off (OFF). Press ENTER key to change actual setting. Notice: if the battery voltage is low, audio indication is out of operation to reduce current consumption independently on this selection.

Clearing of minimum and maximum memory of all values. Memory is cleared after pressing ENTER key. Clearing is confirmed by reading YES on the LCD lower display.

Press ENTER key to display values stored in the HOLD memory. Press DISPLAY key to display other stored values. Press ENTER key to leave this mode.

Time (hour and minute) in internal real time clock of the instrument. Press ENTER key to check date (day, month, year).

Battery voltage of partially loaded battery is displayed. This value illustrates battery condition.

Display refresh mode is indicated. In the FAST mode refreshment is fastest with regular interval approximately 0.7 s. In the dynamic refresh mode (DYN.) each 15 s refresh interval of display is doubled to maximum 5 s if measured values are stable. If measured values change, refresh interval decreases to approximately 0.7 s. This dynamic mode prolongs battery life significantly. Select the desired mode by ENTER key. Notice: if battery voltage is low, the FAST mode is out of operation to reduce current consumption independently on this selection.

Each pressing of ENTER key causes displaying information on storing interval, actual logging mode (MODE), memory occupation (MEMO - in automatic logging mode memory occupation in % is displayed, in manual mode the number of logged values is displayed) and service information on software version (upper LCD line) together with instrument configuration on the LCD lower line.

## Alarm indication and setting

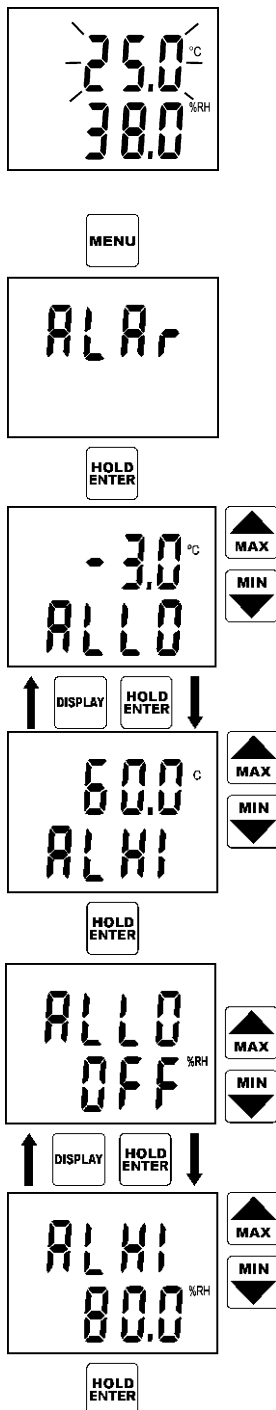

It is possible to set lower and upper limit for each measured quantity. Breaking of the limit is indicated by blinking of the appropriate value on the display. If a new alarm was indicated (i.e. it was not active in the previous measurement), display starts to display the value out of limits. If at least one alarm is active, audio indication can be activated, if menu AUDI "On" is selected (see setting described above). Alarm activation of each value can be disabled by setting lower alarm limit of the desired value up to its maximum. This is indicated by OFF reading at the position of numeric value. Value of upper limit of the same alarm is indifferent.

To set alarms press MENU key, select ALAR from menu items and confirm by pressing ENTER key.

Reading ALLO indicates adjusted lower alarm limit (here air temperature). Set the desired value by means of the arrow keys. Press and hold the arrow key UP to make value increase fast. Press and hold the arrow key DOWN to make value decrease fast. Release the arrow key and press ENTER to confirm new limit.

Reading ALHI indicates adjusted upper limit of the same alarm (here air temperature). Set the desired value in the same way as in above lower limit. If needed it is possible to get back to lower limit setting of the same alarm by pressing DISPLAY key. Press ENTER key to confirm new upper limit.

Then you are offered to set alarm of other input value (here relative humidity). The procedure is the same as the above temperature limit setting. Alarm activation of each value can be disabled by setting lower alarm limit of the desired value up to its maximum. This is indicated by OFF reading at the position of numeric value. Value of upper limit of the same alarm is indifferent.

It is possible to leave the alarm setting mode by pressing MENU key. New adjusted limits up to pressing MENU key are stored in memory.

After pressing ENTER key it is possible to set alarm limits for dew point temperature.

---

## Logging mode

In logging mode measured values are stored to instrument internal memory. Memory is non volatile, i.e. if battery voltage drops or battery is disconnected, stored data will not be lost.

Device can work in two logging modes:

**Automatic mode** – actual measured values are stored to memory in adjustable time interval. Storing of the first value is synchronized with internal real time clock, so the memorizing is performed at sharp multiples of minutes, hours and days. E.g. if the storing interval is 15 minutes value will be stored each 15., 30., 45. a 00. minute and zero second in each hour, if interval is 3 hours values will be stored in 00:00:00, 03:00:00, 06:00:00. etc. It means after starting automatic logging instrument waits for the nearest integer multiple of time and then stores the first value.

**Manual mode** – actual measured value is stored after pressing ENTER key (instrument should be in default mode of displaying actual measured values). Each storing is indicated by a short beep and position of the record in memory is displayed (reading MEMO with the record serial number). In this mode it is possible to store max. 1000 records.

It is possible to select one of the three logging modes (MODE):

**Automatic non cyclic logging**, when logging stops after fulfilling the memory. Reading MEMO FULL is displayed (reading disappears after pressing any key)

**Automatic cyclic logging**, when after fulfilling the memory oldest data are replaced with new values

**Manual logging**, designed for manual storing of measured values by ENTER key

Logging modes are not mutually compatible and after changing logging mode memory of the instrument should be cleared.

Logging in progress will always be interrupted by instrument connection to the computer or switching OFF the instrument by ON/OFF key. Logging in progress will be automatically stopped if battery voltage below 7 V is indicated by the instrument. This prevents to log values effected by low battery voltage.

---

## Logging start from device keyboard

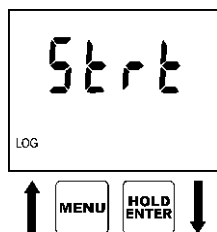

Start logging by confirmation of the menu item START (symbol Strt) by pressing ENTER key.

Notice: it is not possible to start logging if low battery voltage is indicated.



Instrument offers the possibility to clearing the instrument memory (ERAS). If you do not wish to clear the memory before new logging start, confirm selection ERAS NO by pressing the ENTER key.



Now instrument displays adjusted storing interval. To modify the storing interval use arrow keys. Interval 10 sec is displayed as **MIN 0:10**, minute intervals are displayed as **MIN x:00** and hour intervals as **x:Ho**. Confirm adjusted interval by pressing ENTER key. Notice: if manual logging mode is selected, this menu item is skipped (there is no interval adjustment).

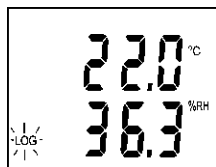

Logging is started and instrument returns to default mode displaying actual values. Logging in progress is in default mode indicated with reading LOG on display. If memory is filled over 90 %, symbol LOG is blinking (only in automatic logging).

## Logging start with clearing memory and logging mode selection

It is possible to clear memory only if logging is stopped. Modification of logging mode is enabled only after memory is cleared. Clearing of memory is optional part of the above procedure logging START. Notice: there is no way to "undelete" the cleared data!

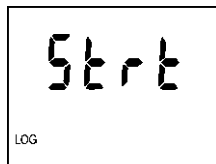

If it is needed to clear the memory before logging start, first it is necessary to select menu item logging START (symbol Strt) and confirm by pressing ENTER key.

Notice: if low battery voltage is indicated, it is not enabled to start logging nor to clear the memory.

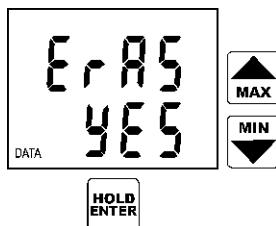

Now instrument offers possibility to clear the memory (ERAS). Default is selection ERAS NO. If clearing of the memory is needed use the arrow keys to select ERAS YES and confirm by pressing ENTER key.

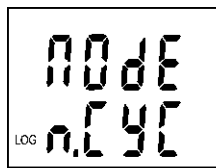
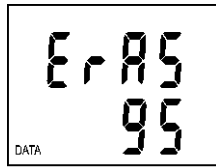

Clearing procedure is in progress. The duration is indicated by displaying of already cleared memory in % (digits 0 to 100).

After memory is cleared it is possible to select one of three logging modes (MODE) by using arrow keys (non cyclic logging is indicated by symbol n.CYC, cyclic logging by symbol CYCL and manual logging by symbol Man). If manual logging mode is selected, after confirmation by ENTER key logging is active. In automatic logging mode (i.e. cyclic or non cyclic) last applied storing interval is offered to confirm or modify. See above procedure.

## Logging stop from keyboard

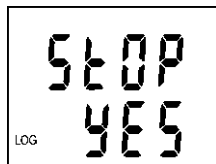
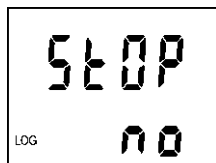
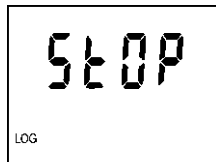

Logging stop is enabled by confirmation of menu item STOP by pressing ENTER key.

Reading STOP NO is displayed to enable logging stop. Use arrow keys to modify to STOP YES. Logging is still in progress.

Logging is stopped after confirmation selection STOP YES by pressing ENTER key. Instrument then returns to default mode of displaying actual values.

---

## Connection of the device to a personal computer

For connection of the instrument to a personal computer is designed the USB communication cable (included in delivery). During time instrument is connected to the computer, there is a reading PC on the LCD display and measurement nor logging is interrupted. Keyboard of the instrument is disabled with the exception of ON/OFF key.

Result of reading data to the computer is a protocol of measurement including instrument serial number and a table of logged values with date and time.

After disconnection of the communication cable reading PC disappears and instrument is in the default mode as after switching on by the ON/OFF key. If logging was in progress before connection to the computer, logging will continue with the same parameters after disconnection of the cable (if new setting of logging was not performed during communication - including logging stop).

**Attention! If you leave the USB cable connected and do not communicate with the device for more than 5 minutes, the device will automatically switched OFF.**



---

# The PC software for the device

---

## Installation of program for PC with OS Windows

Installation program is common for both versions of user program, i.e. basic (freeware) and optional (paid). Installed user program during first run asks licence key - if code is entered, perform the program registration according the displayed instructions and program runs as optional version (otherwise, the program runs in the basic version). Licence key can be entered anytime later.

Installation program is available for free at the Internet address [www.cometsystem.cz](http://www.cometsystem.cz) or can be ordered on the CD as the optional accessory.

- **Installation from the Internet:**

Visit [www.cometsystem.com](http://www.cometsystem.com) and click to link *Programs*. Download *Program for dataloggers Comet* to your computer. After running downloaded file *logger.exe* follow the Installator instruction.

- **Installation from installation CD:**

Insert installation CD to CD-ROM drive and wait for automatic Installator run. If Installator is not run automatically (depends on setting of operating system), find in file browser file *CDSetup.exe* in main directory of the installation CD and click to run. Follow Installator instructions. Select *Program for dataloggers* from the menu.

---

## Software for Windows – instruction manual

### Communication with the instrument

First connect communication cable to USB port of the computer. Plug second connector of communication cable to the instrument and start data transfer to the computer (selection from menu File - from datalogger, key F4 or button on the toolbar). Software will find connection with the instrument and transfer data. Computer offers name of the file with measurement to be created on disk. Implicitly files are stored to files with extension \*.msb. File name is generated from year, month and day of file creation and serial number in the day of creation. It is possible to use different file name and path. After name confirmation it is possible to insert short description with e.g. conditions or location of measurement, which is stored together with measured values.

---

## Viewing of measured values

Measured values can be read directly from datalogger or from formerly created file on disk (command File - From disk, key F3). After reading a table of measured values occurs. Detailed information on file is available from context menu - menu occurs after clicking right mouse button on the position of table. In context menu function export to text or database format is available.

Graph with measured curves can be viewed by command *Display - Graph* or button on the toolbar.

Detailed information on software functions is available in help.

---

## Battery replacement

If battery voltage is low logging mode of the instrument is disabled. Low battery voltage is indicated on the display with blinking reading "BAT". It is necessary to replace it with new one as soon as possible. Battery is located under small cover on the instrument lower side. It is absolutely necessary to replace battery with instrument switched OFF, otherwise internal time and setting of d.REF. and AUDI (from menu selections) and data in memory HOLD, MIN and MAX will be lost. For the same reason do not disconnect the battery for longer than 1 minute even if instrument is switched OFF. If it happens (or if battery is totally discharged), it is necessary to set time from the computer and in appropriate menu selection set again LCD refreshment mode (d.REF.), alarm audio indication (AUDI) and clear the minimum and maximum memory (CLR).

---

## Technical support and service

Technical support and service is provided by distributor. Contact is included in warranty certificate.

# Appendix A

The probe for measuring the moisture of compressed air should be placed directly on the pressure pipelines to achieve higher measurement accuracy and fast response times. But there are cases where such placement is not possible. The reason is the high air speed, high temperature, high pollution, small diameter pipes, etc. Such situation can be solved by placing the probe into the flow measuring chamber. The picture shows the basic layout of the sampling system with flow chamber SH-PP.

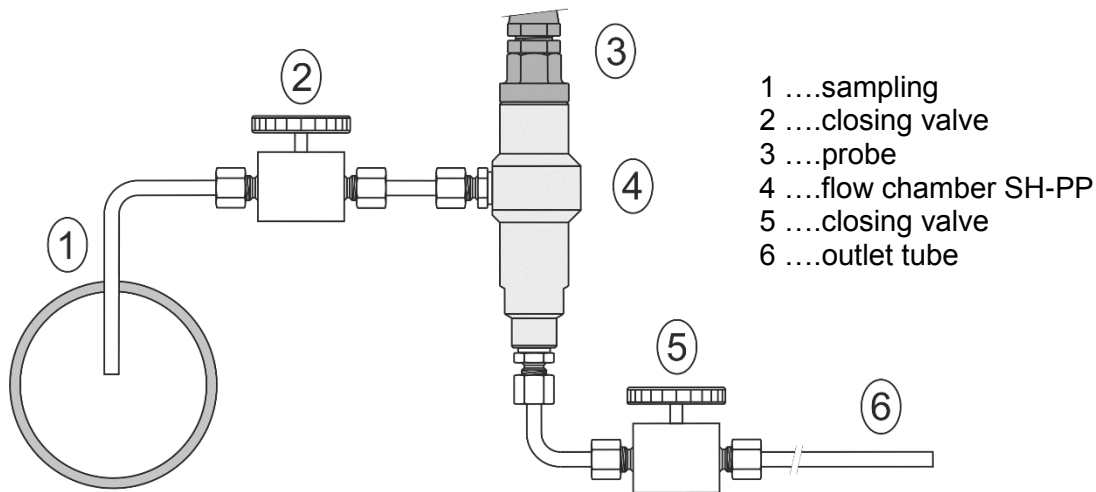

**Sampling (1)** - end of the tube placed in the centre of pressure pipelines (distribution of moisture in the pipe cross-section is not homogeneous). To achieve fast response times to shorten the length of the sample tubes to a minimum (few meters).

**Closing valve (2)** - allows access to the sample system without interrupting the main line

**Closing valve (5)** - the sample flow is regulated by this valve. Measurement accuracy is typically not affected by the sample flow rate, but at low speeds, increasing response time.

**Outlet tube (6)** - if the measured sample of air is released into the atmosphere, select the length of the outlet tube of 1.5 m (recommended for tube diameter 6mm). The reason is to ensure the accuracy of the sample in the flow chamber and avoid back diffusion of moisture from the ambient air.

## Technical specification – flow chamber SH-PP

<b>Material of flow chamber:</b>	stainless steel (DIN 1.4301)
<b>Inlet and outlet connection:</b>	G1/8
<b>Probe connection:</b>	G1/2
<b>Sample flow rate:</b>	0.1 to 3 l/min
<b>Operating pressure:</b>	up to 25 bar
<b>Weight:</b>	580 g

**Note:** Fittings not included in the delivery

